

WHAT IS A COMPUTER?

A computer is a general purpose device or programmable electronic device that can be arranged to carry out a set of arithmetic or logical operations automatically. Since a sequence of operations can be readily changed, the computer can solve more than one kind of problem.

COMPUTER ORGANISATION

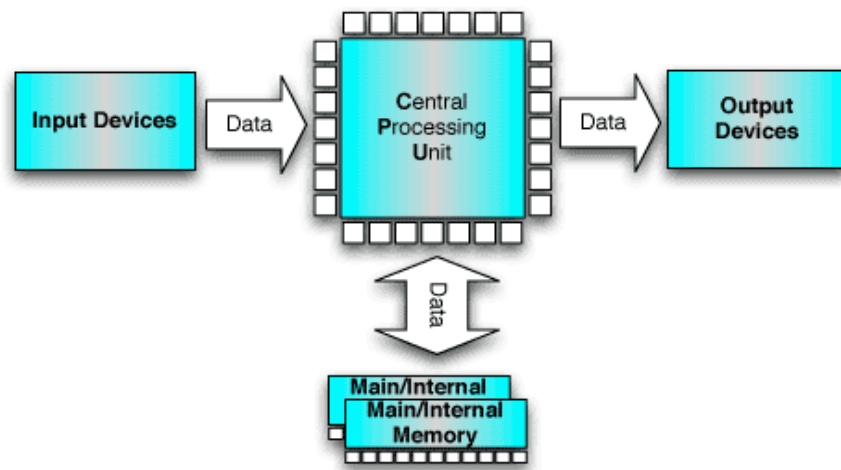

INPUT

MOUSE
KEYBOARD
OCR
BCR
OMR
MICR
STYLUS
SCANNER
JOYSTICK
WEBCAM
LIGHTPEN
TRACKBALL
TOUCHPAD
BIOMETRICS
MICROPHONE
TOUCHSCREEN
QR CODE

PROCESS

MICRO PROCESSOR
RAM/ROM
MOTHERBOARD

OUTPUT

MONITOR
PRINTER
SPEAKER
PLOTTER
PROJECTOR

STORAGE

FLOPPY DISK
HARD DISK
OPTICAL DISC
(CD, DVD, BLU-RAY)
PEN DRIVE

1. INPUT

This is the process of entering data through input devices and programs into the computer system.

2. CONTROL UNIT

The process of input, output, processing and storage is performed under the supervision of a unit called 'Control Unit'. It decides when to start receiving data, when to stop it, where to store data, etc. It takes care of step-by-step processing of all operations inside the computer.

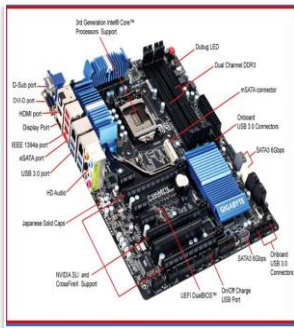

MOTHER BOARD

1. Micro-processor
2. Memory
3. Basic Input/Output System (BIOS)
4. Exp-Slot Expansion
5. Inter-connecting

3. MEMORY UNIT

Computer is used to store data and instructions.

4. ARITHMETIC LOGIC UNIT (ALU)

The major operations performed by the ALU are addition, subtraction, multiplication, division, logic and comparison. The ALU and the CU of a computer system are jointly known as the central processing unit (CPU). You may call CPU as the brain of any computer system.

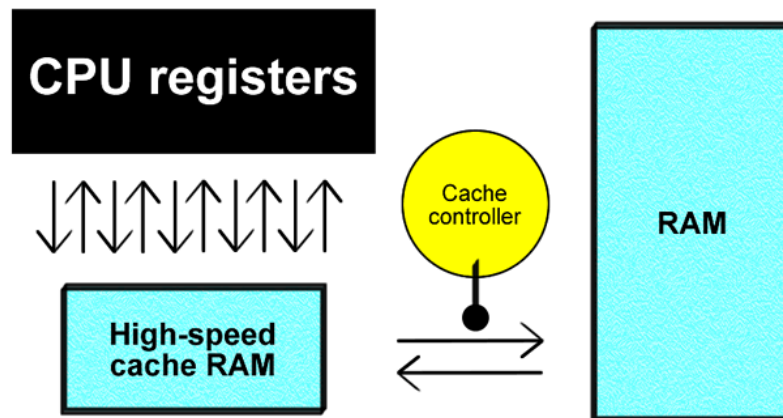

5. OUTPUT

This is the process of producing results from the data for getting useful information.

NON IMPACT PRINTERS

- Four types of Non Impact printers are: **LASER** printers, **INKJET** printers, **PLOTTERS** and **THERMAL** printers.

Laser Printer	Inkjet Printer	Thermal Printer	Plotter

MEMORY AND MEMORY UNIT

The **computer memory** is a temporary storage area. It holds the data and instructions that the Central Processing Unit (CPU) needs. Before a program can be run, the program is loaded from some storage medium into the memory. This allows the CPU direct access to the program. Memory is a need for any computer.

There are two type of nature in the memory device

- **Temporary / Volatile**
- **Permanent / Non volatile**

Volatile memory

It is computer storage that only maintains its data while the device is powered on. RAM (random access memory) used for primary storage in personal computers as a volatile memory.

Non Volatile Memory

It is a type of computer memory that has the capability to hold saved data even if the power is turned off. ROM (Read Only Memory) is the example of non-volatile memory.



BUY FROM
myshop.mahendras.org
CALL US (TOLL FREE)
1800 103 5225

ATTEMPT DAILY
1 SPEED TEST
EXCLUSIVELY FOR IBPS RRB PO MAINS 2017

AVAIL FLAT
50% DISCOUNT
USE PROMOCODE - **RRBMNS4D97C4**

LIMITED
OFFER

25 SETS

VALID TILL 5TH NOVEMBER 2017

PRIMARY MEMORY

RAM: RAM (Random Access Memory) is a form of computer data storage. A random-access device allows stored data to be accessed directly in any random order. It is a volatile memory.

DDR SDRAM: Double data rate synchronous dynamic RAM is just like SDRAM except that it has higher bandwidth, meaning greater speed. EX- DDR1, DDR2, DDR3, DDR4.

SDRAM: **Synchronous dynamic random access memory** takes advantage of the burst mode concept to greatly improve performance.

VRAM: **Video RAM**, also known as **Multiport Dynamic Random Access Memory (MPDRAM)**, is a type of RAM used specifically for video adapters or 3-D accelerators.

ROM (READ ONLY MEMORY)

It is non-volatile memory that stores **BIOS** instructions as are required to start computer when electricity is first turned on.

Types of ROM

➤ **EPROM (Erasable and Programmable Read Only Memory)**

The EPROM can be erased by exposing it to ultra-violet light then rewriting. It is also called ultra violet PROM.

➤ **EEPROM (Electrically Erasable and Programmable Read Only Memory)**

The EEPROM is programmed and erased electrically. In EEPROM, any location can be selectively erased and programmed. EEPROMs can be erased one byte at a time, rather than erasing the entire chip.

CACHE MEMORY

A cache used by the central processing unit (CPU) of a computer to reduce the average time to access memory. It is used in between the main memory and CPU.

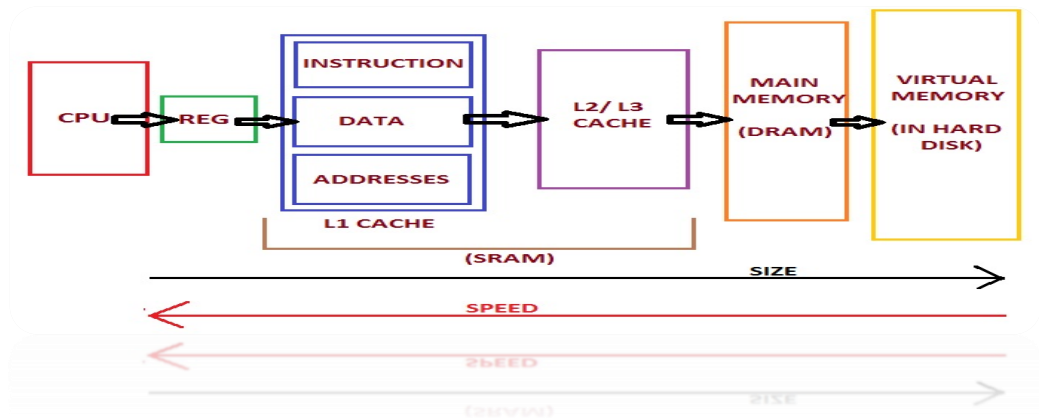

VIRTUAL MEMORY

Virtual memory combines your computer's RAM with temporary space on your hard disk. When RAM runs low, virtual memory moves data from RAM to a space called a paging file. Moving data to and from the paging file frees up RAM so your computer can complete its work. It is also called Extended RAM.

SECONDARY STORAGE

It is used to store data for backup purpose.

Types of Access:

- **Sequential access**
- **Direct/Random access**
- **Hard drives, flash drives** and almost all other storage devices are direct access. This means that data stored anywhere on the device can be accessed in an equally short space of time.

- **Magnetic tape** is a serial access or sequential access device. This means that you have to wind through it to reach a piece of data that you require.
- Magnetic tape consists of a plastic tape covered in a magnetic coating.
- Based on sequential access.
- **HARD DISK:** - Permanent/Non-Volatile Storage Device.
- Device used for storing and retrieving digital information using rapidly rotating disks coated with magnetic material. Data is read in a random access method.

SOLID STATE DRIVE

Solid-state drives actually aren't hard drive in the traditional sense of the term, as there are no moving parts involved. A traditional hard disk drive (**HDD**) consists of a spinning disk with a read/write head on a mechanical arm. An SSD, on the other hand, has an array of semiconductor memory organized as a disk drive, using integrated circuits (ICs) rather than magnetic or optical storage media

OPTICAL DISC

In computing, an optical disc drive (ODD) is a disk drive that uses laser light or electromagnetic waves near the light spectrum as part of the process of reading or writing data to or from optical disc.

Optical storage refers to the storage of data on an optically readable medium.

CD (Compact disc)- CD is an Optical Medium. This means that data is written to it, and read from it using a laser.

DVD (Digital versatile disc):- It is an optical disc like the CD, but with much higher capacity. There are many different types, but the standard DVD can store about 4.7GB.

BRD (blue ray disc):- Blu-ray Disc is a high-density Optical Disc format similar to DVD.

Its Storage Capacity upto 50 GB to 100 GB.

HVD (holographic versatile disc):- The Holographic Versatile Disc (HVD) is an Optical Disc Technology, its Storage Capacity upto 6 TB



YOUR SUCCESS IS OUR SUCCESS

MAHENDRA

GURU

Specialized in Banking, SSC, Railway & other Competitive Examinations



PRINTER

IMPACT PRINTER

- Dot Matrix Printer
- Line Printer
- Daisy Wheel

DOT MATRIX

Dot-matrix printers are now almost extinct. They used a ribbon and made a lot of noise. There were models with 9 pins and models with 24 pins.

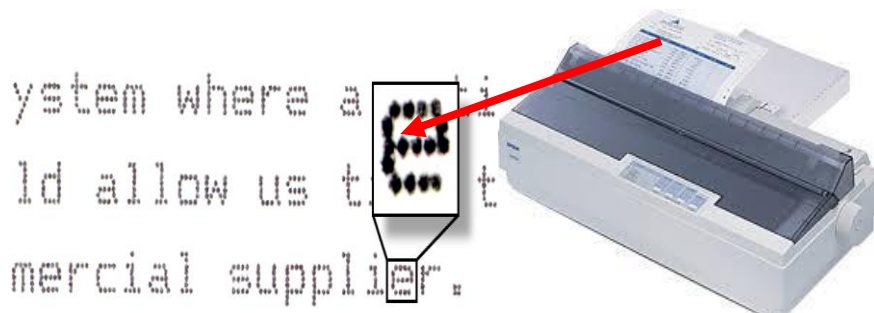

NON-IMPACT PRINTER

- Ink-Jet Printer
- Laser Printer
- Thermal Printer
- Special purpose Printer

DAISY WHEEL

Daisy-wheel printers, consist of a circular wheel about 3 inches in diameter with arms or spokes. The character shape is embossed at the outer ends of the spokes. The shape of the printer wheel resembles the petals of a daisy flower and hence, it is named daisy wheel printer.

	Dot Matrix	Ink Jet	Laser
Ink	Ribbon	Liquid	Toner
Paper Feed	Tractor-fed	Sheet-fed	Sheet-fed
Line or Page	Line	Line	Page
Impact or Non-Impact	Impact	Non-impact	Non-Impact
Color	No	Yes	Some

Pdf Download from: www.Sarkaripost.in

SOFTWARE

Non- Functional Requirements

- Constraints that must be accomplished or adhered to ...
 - *Response time*
 - *Throughput*
 - *Resource usage*
 - *Reliability*
 - *Availability*
 - *Security*
 - *Recovery from failure*
 - *Cost*
 - *Technology to be used*

As you are aware, computer cannot do anything on its own. It is the user who instructs computer; what to do, how to do and when to do. In order to perform any task, you have to give a set of instructions in a particular sequence to the computer. These sets of instructions are called Programs. Software refers to a set of programs that makes the hardware perform a particular set of tasks in particular order.

SYSTEM SOFTWARE

- Operating System
- Translator
- Linker/Loader

APPLICATION SOFTWARE

- Word Processing / Spreadsheet Software
- Multi-media Software
- Game etc.

Functional Requirements

- Describe **what** the system should do
- What inputs/outputs
- What data the system should store
- What computations the system should perform
- Concepts, functions, features, information, Behaviors. These are generally listed as **shall statements** starting with "The system shall ...".

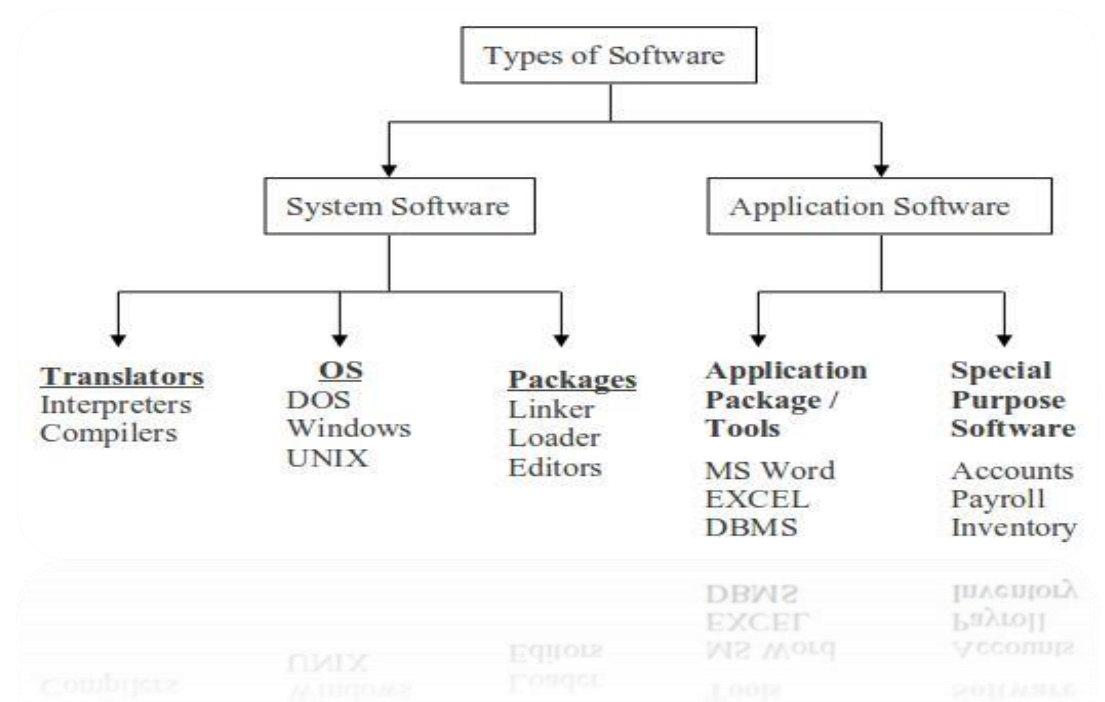

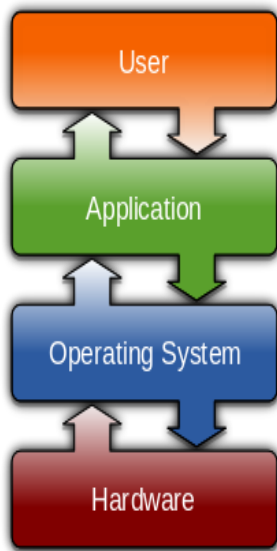

SYSTEM SOFTWARE

Programs that support the execution and development of other programs. These are compulsory software for the computer system, without which computer cannot work. For example Operating System, Translator etc.

Operating System: Operating System is software which acts as an interface between user and computer hardware.

Single Tasking Operating System: A single task OS has to deal with the requests of the single person using the computer at that time.

Multi-User Operating System: Systems allows lots of people to access the resources of the mainframe computer.

Multi-Tasking Operating System: Multitasking means to run more than one program at once.

APPLICATION SOFTWARE

Application software is a set of programs, which are written to perform specific tasks, for example Word Processor, Adobe Photoshop, Media players, Game etc. An application package for managing library known as library information system is used to manage information of library such as: keeping book details, account holder details, book issue details, book return details etc. Application software can be broadly classified into two types:

(a) Horizontal Software (b) Vertical Software

Horizontal: Those Software which are being used widely i.e. from individual user to big organization is using the software like MS-Office, Adobe Photoshop, Tally etc.

Vertical: Software which is developed for particular organization is known as vertical software.

Utility Software:

Small and useful programs which support all devices are called utility software.

Some Examples:

Device Driver
Disk
Defragment
Compression Software
Antivirus



COMPUTER NETWORKING

When one or more computer or networking devices are connected to each other is called Computer Networking. There are three types of Networking.

LOCAL AREA NETWORK (LAN)

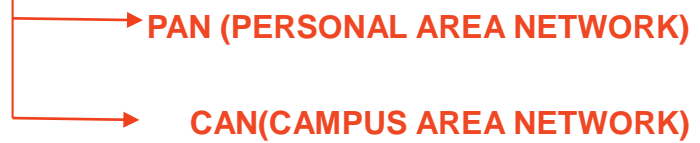

- small geographic area (e.g. room, office)
- controlled by one administrative authority
- usually high speed
- always shared

WIDE AREA NETWORK(WAN)

- Computer network that covers a broad area
- Crosses Metropolitan, Regional, or National Boundaries

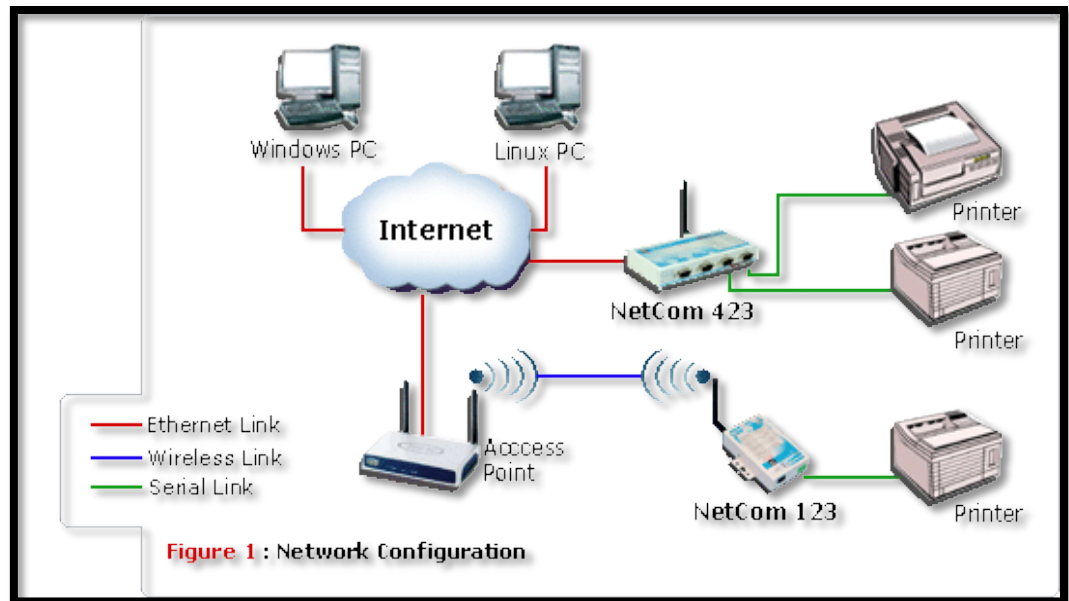
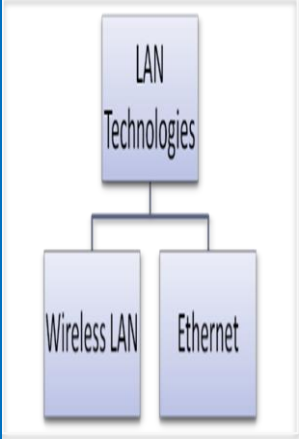

Figure 1 : Network Configuration

TOPOLOGY

STAR TOPOLOGY

ADVANTAGES OF A STAR TOPOLOGY

- Easy to install and wire.
- No disruptions to the network when connecting or removing devices.
- Easy to detect faults and to remove parts.

DISADVANTAGES OF A STAR TOPOLOGY

- Requires more cable length than a linear topology.
- If the hub, switch, or concentrator fails, nodes attached are disabled.
- More expensive than linear bus topologies because of the cost of the hubs, etc.



BUS TOPOLOGY

ADVANTAGES OF LINEAR BUS

- Simple set-up and Least expensive layout
- Uses inexpensive thin coax cable
- Doesn't require a hub

DISADVANTAGES OF LINEAR BUS

- Slow
- Inappropriate for large networks

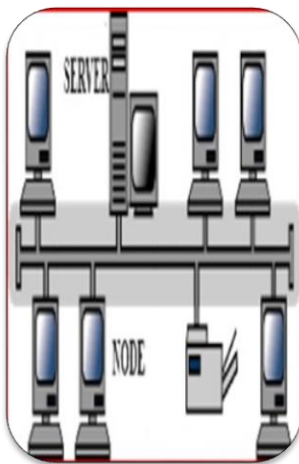

RING TOPOLOGY

ADVANTAGES OF RING TOPOLOGY

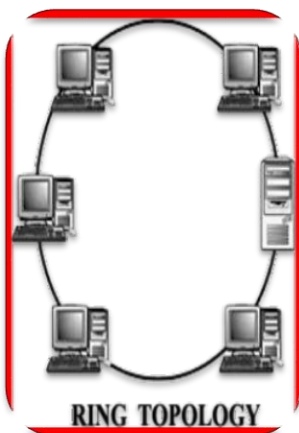

- Easy set-up

DISADVANTAGES OF RING TOPOLOGY

- Difficult to add and remove devices once the network has been set up.



INTERNET

The *Internet* is the global system of interconnected computer networks that use the *Internet* protocol suite (TCP/IP) to link billions of devices worldwide. Unlike online services, which are centrally controlled, by design, the Internet is decentralized.



ARPANET

The Advanced Research Projects Agency Network (ARPANET) was an early packet switching network and the first network to implement the protocol suite TCP/IP.

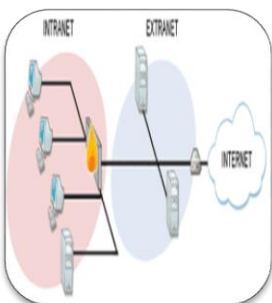

Intranet

An intranet is a network based on TCP/IP protocols (an internet) belonging to an organization, usually a corporation, accessible only by the organization's members, employees, or others with authorization. Like the Internet itself, intranets are used to share information. Secure intranets are now the fastest-growing segment of the Internet because they are much less expensive to build and manage than private networks based on proprietary protocols.

Pdf Download from: www.Sarkaripost.in

Extranet

An extranet is a website that allows controlled access to partners, vendors and suppliers or an authorized set of customers - normally to a subset of the information accessible from an organization's intranet.

AVAILABLE CARDS ON MYSHOP
myshop.mahendras.org

Mahendra's
YOUR SUCCESS IS OUR SUCCESS
Specialized in Banking, SSC, Railway & other Competitive Examinations

IBPS
प्रज्ञाविभावनम्

INDIAN RAILWAY

SSC

Mahendra's
SBI CLERK SPECIAL SPEED TEST CARD
₹100/- ONLY
3 MONTHS VALIDITY
50 SPEED TEST
50 PRACTICE TEST
Toll Free No. 1800-103-5225
OTP NUMBER

Mahendra's
ONLINE SPEED TEST CARD RAILWAY
₹100/- ONLY
45 Online Speed Test
45 Online Practice Speed Test
3 Months Validity
Toll Free No. 1800-103-5225
OTP NUMBER

BANKING ONLINE SPEED TEST
15 ONLINE TESTS
15 PRACTICE TESTS
VALIDITY 1 MONTH
₹100
TOLL FREE - 1800-103-5225

SBI-CLERK CARD
Extra ₹100 Discount

Railway Card
Extra 100₹ Discount

SSC ONLINE SPEED TEST
15 ONLINE TESTS
15 PRACTICE TESTS
VALIDITY 1 MONTH
₹100
TOLL FREE - 1800-103-5225

www.mahendras.org | www.mahendraskills.org | www.mahendraguru.com

IMPORTANT SHORTCUT KEYS

Alt + F	File menu options in current program.
Alt + E	Edit options in current program
Alt + Tab	Switch between open programs
F1	Universal Help in almost every Windows program.
F2	Rename a selected file
F5	Refresh the current program window
Ctrl + N	Create a new, blank document in some software programs
Ctrl + O	Open a file in current software program
Ctrl + A	Select all text.
Ctrl + B	Change selected text to be Bold
Ctrl + I	Change selected text to be in Italics
Ctrl + U	Change selected text to be Underlined
Ctrl + F	Open find window for current document or window.
Ctrl + S	Save current document file.
Ctrl + X	Cut selected item.
Shift + Del	Cut selected item.
Ctrl + C	Copy selected item.
Ctrl + Ins	Copy selected item
Ctrl + V	Paste
Shift + Ins	Paste
Ctrl + K	Insert hyperlink for selected text
Ctrl + P	Print the current page or document.
Home	Goes to beginning of current line.
Ctrl + Home	Goes to beginning of document.
End	Goes to end of current line.
Ctrl + End	Goes to end of document.
Shift + Home	Highlights from current position to beginning of line.
Shift + End	Highlights from current position to end of line.
Ctrl + Left arrow	Moves one word to the left at a time.
Ctrl + Right arrow	Moves one word to the right at a time.
Ctrl + Esc	Opens the START menu

MCQ'S

Q1.Which key is used in combination with another key to perform a specific task?

- 1. Function**
- 2. Control**
- 3. Arrow**
- 4. Space bar**
- 5. None of these**

ANS (2)-Control

Q2.Multiple choice examination answer sheets can be evaluated automatically by?

- 1. Optical Character Reader**
- 2. Optical Mark Reader**
- 3. Magnetic tape reader**
- 4. Magnetic ink character reader**
- 5. None of these**

ANS (2)-Optical Mark Reader

Q3.A set of flip flops integrated together is called ____?

- 1. Counter**
- 2. Adder**
- 3. Register**
- 4. Flip flop**
- 5. All of the above**

ANS (3)-Register

Q4.Which of the following is used for close a tab on a browser?

- 1. Ctrl + T**
- 2. Ctrl + W**
- 3. Ctrl + A**
- 4. Ctrl + Y**
- 5. None of these**

ANS (2)-Ctrl + W

Q5.The first electronic computer was developed by?

- 1. J.V. Attansoff**
- 2. Bill Gates**
- 3. Seymour Cray**
- 4. Vinton Cerf**
- 5. Charles Babbage**

Ans (1) - J.V. Attansoff

Pdf Download from: www.Sarkaripost.in

Q6.The ALU of a computer responds to the commands coming from?

- 1. Primary memory**
- 2. Control section**
- 3. External memory**
- 4. Cache memory**
- 5. None**

ANS (2)-Control section

Q7.A computer checks the _____ of user names and passwords for a match before granting access?

- 1. Website**
- 2. Network**
- 3. Backup file**
- 4. Database**
- 5. None of these**

ANS (4)-Database

Q8.What is the name given to the molecular-scale computer?

- 1. Minicomputer**
- 2. Nano computer**
- 3. Supercomputer**
- 4. Microcomputer**
- 5. None of the above**

ANS (2)- Nanocomputer

Q9. The primary memory of a personal computer consists of?

1. ROM only
2. RAM only
3. Both ROM and RAM
4. Memory module
5. None of the above

ANS (3)-Both ROM and RAM

Q10. Press _____ to move the insertion point to the Address box, or to highlight the URL in the Address box?

1. ALT + D
2. ALT + A
3. SHIFT + TAB
4. TAB + CTRL
5. CTRL + S

ANS (1)-ALT + D

Q11. A (n) _____ appearing on a web page opens another document when clicked?

1. Anchor
2. URL
3. Hyperlink
4. Reference
5. None of these

ANS (3)-Hyperlink

Q12. Which of the following refers to the rectangular area for displaying information and running programs?

- 1. Desktop**
- 2. Dialog box**
- 3. Menu**
- 4. Window**
- 5. None of these**

ANS (1)-Desktop

Q13. Which of these is not a means of personal communication on the internet?

- 1. Chat**
- 2. Instant messaging**
- 3. Instanotes**
- 4. Electronic mail**
- 5. None of these**

ANS (3)- Instanotes

Q14. Is the layer of a computer system between the hardware and the user program?

- 1. Operating environment**
- 2. Operating system**
- 3. System environment**
- 4. Utility software**
- 5. Spooler**

ANS (2)-Operating system

Pdf Download from: www.Sarkaripost.in

Q15.The symbols used in an assembly language are?

- 1. Codes**
- 2. Mnemonics**
- 3. Assembler**
- 4. All of the above**
- 5. None of the above**

ANS (2)-Mnemonics

Q16.The list of coded instructions is called?

- 1. Computer program**
- 2. Algorithm**
- 3. Flowchart**
- 4. Utility programs**
- 5. None of the above**

ANS (1)-Computer program

Q17.A memory bus is mainly used for communication between?

- 1. Processor and memory**
- 2. Processor and I/O devices**
- 3. I/O devices and memory**
- 4. Input device and output device**
- 5. None of the above**

ANS (1)-Processor and memory

Q18.What is the name of the computer terminal which gives paper printout?

- 1. Display screen**
- 2. Soft copy terminal**
- 3. Hard copy terminal**
- 4. Plotter**
- 5. None of the above**

ANS (3)-Hard copy terminal

Q19.Which of the following is non-impact printer?

- 1. Drum printer**
- 2. Line printer**
- 3. Chain printer**
- 4. Laser printer**
- 5. None of the above**

ANS (4)-Laser printer

Q20.Which of the following memories needs refresh?

- 1. SRAM**
- 2. DRAM**
- 3. ROM**
- 4. All of the above**
- 5. None of the above**

ANS (2)-DRAM

Q21. Which type of memory is not directly addressable by the CPU and requires special software called EMS?

1. Extended
2. Expanded
3. Base
4. Conventional
5. None of these

ANS (2)-Expanded

Q22. The original ASCII code used _____ bits of each byte, reserving that last bit for error checking?

1. 5
2. 6
3. 7
4. 8
5. 10

ANS (3)-7

Q23. Which Company is the biggest player in the microprocessor industry?

1. Motorola
2. IBM
3. Intel
4. AMD
5. All of these

ANS (3)-Intel

Q24. A high quality CAD system uses the following for printing drawing and graphs?

- 1. Dot matrix printer**
- 2. Digital plotter**
- 3. Line printer**
- 4. Scanner**
- 5. All of the above**

ANS (2)-Digital plotter

Q25. Symbolic logic was discovered by _____?

- 1. George Boole**
- 2. Herman Hollerith**
- 3. Vonn Neumann**
- 4. Basic Pascal**
- 5. Sun Microsystem**

ANS (1)-George Boole

Q26. Can you tell what passes into and out from the computer via its ports _____?

- 1. Data**
- 2. Bytes**
- 3. Graphics**
- 4. Pictures**
- 5. Information**

ANS (1)-Data

Q27. Which type of computers uses the 8-bit code called EBCDIC?

- 1. Minicomputers**
- 2. Microcomputers**
- 3. Mainframe computers**
- 4. Super computer**
- 5. Desktop**

ANS (3)-Mainframe computers

Q28. Computer instructions written with the use of English words instead of binary machine code is called?

- 1. Mnemonics**
- 2. Symbolic code**
- 3. Gray codes**
- 4. Opcode**
- 5. Barcode**

ANS (2)-Symbolic code

Q29. CD-ROM _____?

- 1. Is a semiconductor memory**
- 2. Memory register**
- 3. Magnetic memory**
- 4. None of the above**
- 5. All of these**

ANS (4)-None of the above

Q30. A name or number used to identify a storage location is called?

1. A byte
2. A record
3. An address
4. Data
5. All of above

ANS (3)-An address

Q31. What is the default folder used to store incoming email messages called?

1. Mailbox
2. Tempbox
3. Inbox
4. Mybox
5. Drafts

ANS (3)-Inbox

Q32. What is the opposite of a static website?

1. Multilingual website
2. Dynamic website
3. Recently published website
4. Responsive website
5. None of these

ANS (2)-Dynamic website

Q33. A machine _____ that links two networks using different protocols?

- 1. Router**
- 2. Switch**
- 3. Star**
- 4. Ring**
- 5. Gateway**

ANS (5)-Gateway

Q34.HTTP, FTP, and TCP/IP are all different types of what?

- 1. Websites**
- 2. File Systems**
- 3. Protocols**
- 4. Software Programs**
- 5. Internet files**

ANS (3)-Protocols

Q35.What is the process of smoothing out digital noise in graphics called?

- 1. Refracting**
- 2. Rounding**
- 3. Flattening**
- 4. Dithering**
- 5. None of these**

ANS (4)-Dithering

Q36.What is the technical name of an electronic version of a document?

1. Soft copy
2. Virtual copy
3. Computer copy
4. e-Copy
5. Hard copy

ANS (1)-Soft copy

Q37.How can you increase the font size of selected text by one point every time?

1. By pressing Ctrl +]
2. By pressing Ctrl + [
3. By pressing Ctrl +}
4. By pressing Ctrl+{
5. None of the Above

ANS (1)-By pressing Ctrl +]

Q38.The blinking symbol on the computer screen is called?

1. Mouse
2. Logo
3. Hand
4. Palm
5. Cursor

ANS (5)-Cursor

Q39. Main circuit board in a computer?

1. Decoder
2. Highlight
3. Select
4. Mother board
5. Bus

ANS (4)-Mother board

Q40.To “maximize” a window means to?

1. Expand it to fit the desktop
2. Fill it to capacity
3. Put only like files inside
4. Drag it to the trash
5. None of these

ANS (1)-Expand it to fit the desktop

Q41.Which of the following may be necessary for you to do after you install new application software?

1. Turn the computer power switch off and then back on
2. Do a warm boot
3. Press Shift + Alt + Del
4. Do a cold boot
5. None of these

ANS (2)-Do a warm boot

Q42. Which of the following is NOT part of the motherboard?

- 1. CPU**
- 2. Chipset**
- 3. System clock**
- 4. Connector**
- 5. None of these**

ANS (4)-Connector

Q43. A record of columns in DBMS is called?

- 1. Field**
- 2. Label**
- 3. Matrix**
- 4. Tuple**
- 5. None of these**

ANS (1)-Field

Q44. The most important or power-full computer in a typical network is?

- 1. Network station**
- 2. Network server**
- 3. Network client**
- 4. Desktop**
- 5. None of these**

ANS (2)-Network server

Q45. In which of the following form, data is stored in computer?

- 1. Binary**
- 2. Octal**
- 3. Hexa-Decimal**
- 4. Octal**
- 5. None of these**

ANS (1)-Binary

Q46. Who was the Founder of Bluetooth?

- 1. Andy Rubin**
- 2. Martin Cooper**
- 3. Ericson**
- 4. Steve Jobs**
- 5. None of these**

ANS (3)-Ericson

Q47. Devices that let the computer communicate with you are called?

- 1. Input devices**
- 2. Output devices**
- 3. Type devices**
- 4. Print devices**
- 5. None of these**

ANS (2)-Output devices

Q48.The smallest item of useful information that a computer can handle is called?

- 1. Bait**
- 2. Bit**
- 3. Byte**
- 4. Bite**
- 5. None of these**

ANS (2)-Bit

Q49.Transmission media are usually categorized as?

- 1. Determinate or indeterminate**
- 2. Fixed or unfixed**
- 3. Guided or unguided**
- 4. Neither 1 and 2**
- 5. All of the above**

ANS (3)-Guided or unguided

Q50.Which one of the following is a guided transmission line?

- 1. Pair of wires**
- 2. Optical fiber cable**
- 3. Coaxial cable**
- 4. Twisted pair**
- 5. All of the above**

ANS (5)-All of the above

Q51. Which output device is used for translating information from a computer into pictorial form on paper?

- 1. Mouse**
- 2. Plotter**
- 3. Touch panel**
- 4. Card punch**
- 5. None of these**

ANS (2)-Plotter

Q52. The list of coded instructions is called?

- 1. Computer program**
- 2. Algorithm**
- 3. Flowchart**
- 4. Utility programs**
- 5. None of these**

ANS (1)-Computer program

Q53. A process known as _____ is used by large retailers to study trends?

- 1. Data mining**
- 2. Data selection**
- 3. POS**
- 4. Data conversion**
- 5. None of these**

ANS (1)-Data mining

Q54. The two basic types of record-access methods are?

- 1. Sequential and random**
- 2. Direct and immediate**
- 3. Sequential and indexed**
- 4. On-line and real time**
- 5. None of these**

ANS (1)-Sequential and random

Q55. What is meant by a dedicated computer?

- 1. Which is used by one person only**
- 2. Which is assigned one and only one task**
- 3. Which uses one kind of software**
- 4. Which is meant for application software**
- 5. None of these**

ANS (2)-Which is assigned one and only one task

Q56. A Proxy server is used for which of the following?

- 1. To provide security against unauthorized users**
- 2. To process client requests for web pages**
- 3. To process client requests for database access**
- 4. To provide TCP/IP**
- 5. None of the above**

ANS (1)-To provide security against unauthorized users

Q57.A _____ is approximately a million bytes?

- 1. Gigabyte**
- 2. Kilobyte**
- 3. Megabyte**
- 4. Terabyte**
- 5. None of these**

ANS (3)-Megabyte

Q58. _____ are used to identify a user who returns to a Website.

- 1. Cookies**
- 2. Plug-ins**
- 3. Scripts**
- 4. ASPs**
- 5. None of these**

ANS (1)-Cookies

Q59.What is correcting errors in a program called?

- 1. Interpreting**
- 2. Translating**
- 3. Debugging**
- 4. Compiling**
- 5. None of these**

ANS (3)-Debugging

Pdf Download from: www.Sarkaripost.in

Q60.A device that provides emergency power to your computer, conditions the voltage, and protects against power surges is called?

- 1. PSU = Power Supply Unit**
- 2. USP = Universal Surge Protector**
- 3. UPPS = Universal Power Protection and Supply**
- 4. UPS = Uninterruptible Power Supply**
- 5. None of the above**

ANS (4)-UPS = Uninterruptible Power Supply

Q61.What menu is selected to cut, copy and paste?

- 1. File**
- 2. Tools**
- 3. Special**
- 4. Edit**
- 5. Styles**

ANS (4)-Edit

Q62.What type of resource is most likely to be a shared common resource in a computer network?

- 1. Keyboards**
- 2. Speakers**
- 3. Floppy disk drives**
- 4. Printers**
- 5. Mouse**

ANS (4)-Printers

Q63. Graphics for word processor is known as?

- 1. Peripheral**
- 2. Clip art**
- 3. Highlight**
- 4. Execute**
- 5. Image art**

ANS (2)-Clip art

Q64. Periodically adding, changing and deleting file records is called?

- 1. Updating**
- 2. Upgrading**
- 3. Restructuring**
- 4. Renewing**
- 5. None of above**

ANS (1)-Updating

Q65. What is the extension of files created in Ms-Word 97- 2003?

- 1. Dot**
- 2. Doc**
- 3. Dom**
- 4. Txt**
- 5. Wrd**

ANS (2)-Doc

Q66. BISYNC is an abbreviation for?

- 1. Binary Input/Binary Output**
- 2. Binary synchronous**
- 3. Binary digit**
- 4. All of the above**
- 5. None of these**

ANS (2)-Binary synchronous

Q67. If you see a small red triangle in the top right corner of a cell, it means there is something attached to the cell, what is it?

- 1. A comment**
- 2. An attachment**
- 3. An error**
- 4. All of the above**
- 5. None of these**

ANS (1)-A comment

Q68. A passive threat to computer security is?

- 1. Malicious Intent**
- 2. Sabotage**
- 3. Accident Errors**
- 4. Espionage Agents**
- 5. None of these**

ANS (1)-Malicious Intent

Q69. An incremental backup?

- 1. Uses more tapes**
- 2. Should be done each month**
- 3. Saves only files that have recently changed**
- 4. Save files that has not recently changed**
- 5. Save two copy of unsaved data**

ANS (3)-Saves only files that have recently changed

Q70. These type of viruses is often transmitted by a floppy disk left in the floppy drive?

- 1. Trojan horse**
- 2. Boot sector**
- 3. Script**
- 4. Logic bomb**
- 5. None of these**

ANS (2)-Boot sector

Q71. Which terminals (formerly known as cash registers) are often connected to complex inventory and sales computer systems?

- 1. Data**
- 2. Point-of-sale (POS)**
- 3. Information**
- 4. Sales**
- 5. Query**

ANS (2)-Point-of-sale (POS)

Q72.Name those tags which when placed on an animal, can be used to record and track in a database of the animals movements?

- 1. GPS**
- 2. PPS**
- 3. POS**
- 4. PSS**
- 5. RFID**

ANS (5)-RFID

Q73.Which menu is selected to cut, copy, and paste?

- 1. Edit**
- 2. File**
- 3. Format**
- 4. View**
- 5. Help**

ANS (1)-Edit

Q74.The most advanced form of ROM is?

- 1. PROM**
- 2. RAM**
- 3. Cache memory**
- 4. EEPROM**
- 5. None of these**

ANS (4)-EEPROM

Q75. Which of the following refers to too much electricity and may cause a voltage surge?

- 1. Spike**
- 2. Anomaly**
- 3. Shock**
- 4. Virus**
- 5. None of these**

ANS (1)-Spike

Q76. Walkie-Talkie is example of?

- 1. Simplex Channel**
- 2. Half duplex Channel**
- 3. Full duplex Channel**
- 4. Hybrid Channel**
- 5. None of these**

ANS (2)-Half duplex Channel

Q77. You can detect spelling and grammar errors by?

- 1. Press Shift + F7**
- 2. Press Ctrl + F7**
- 3. Press Alt+ F7**
- 4. Press F7**
- 5. Press F8**

ANS (4)-Press F7

Q78. An integrated circuit is?

- 1. A complicated circuit**
- 2. An integrating device**
- 3. Much costlier than a single transistor**
- 4. Fabricated on a tiny silicon chip**
- 5. None of these**

ANS (4)-Fabricated on a tiny silicon chip

Q79. Founder of Google?

- 1. Larry Page, Sergey Brin**
- 2. Tim Cook, Andy Rubin**
- 3. VA Shiva Ayyadurai**
- 4. Tim Berners-Lee**
- 5. Marc Andreessen**

ANS (1)-Larry Page, Sergey Brin

Q80. Founder of Flipkart?

- 1. Jeff Bezos, Andy Rubin**
- 2. Sachin Bansal, Binny Bansal**
- 3. Sanjeev Agrawal**
- 4. Rohit Bansal, KunalBahl**
- 5. Tim Cook, Andy Rubin**

ANS (2)-Sachin Bansal, Binny Bansal

Q81.What is the maximum font size you can apply for any character?

1. 163
2. 1638
3. 16038
4. 160038
5. None of above

ANS (2)-1638

Q82.Thesaurus tool in MS Word is used for?

1. Spelling suggestions
2. Grammar options
3. Synonyms and Antonyms words
4. All of above
5. None of these

ANS (3)-Synonyms and Antonyms words

Q83.How long is an IPv6 address?

- 1.32 bits
- 2.128 bytes
- 3.64 bits
- 4.128 bits
5. None of these

ANS (4)-128 bits

Q84. Where is a hub specified in the OSI model?

- 1. Session layer**
- 2. Physical layer**
- 3. Data Link layer**
- 4. Application layer**
- 5. Transport layer**

ANS (2)-Physical layer

Q85. Which protocol does Ping use?

- 1. TCP**
- 2. ARP**
- 3. ICMP**
- 4. BootP**
- 5. None of these**

ANS (3)-ICMP

Q86. Where does encryption and decryption of data take place in OSI model?

- 1. Transport layer**
- 2. Presentation layer**
- 3. Session layer**
- 4. Application layer**
- 5. None of these**

ANS (2)-Presentation layer

Q87.where we can find embedded operating system?

- 1. Desktop operating system**
- 2. On network pc**
- 3. On network server**
- 4. On PDA**
- 5. On mainframe**

ANS (4)-On PDA

Q88.During the _____ operation, the control unit determines what the program is telling the computer to do?

- 1. Fetch**
- 2. Execute**
- 3. Decode**
- 4. Arithmetic**
- 5. None of these**

ANS (3)-Decode

Q89.Who was the father of Internet?

- 1. Chares Babbage**
- 2. Vint Cerf**
- 3. Denis Riche**
- 4. Martin Cooper**
- 5. None of these**

ANS (2)-Vint Cerf

Pdf Download from: www.Sarkaripost.in

Q90.WPA2 is used for security in?

- 1. Ethernet**
- 2. Bluetooth**
- 3. Wi-fi**
- 4. None of the above**
- 5. Router**

ANS (3)-Wi-Fi

Q91.Linux was developed by?

- 1. Ken Thompson**
- 2. Andy Rubin**
- 3. Linus Torvalds**
- 4. Dennis Ritchie**
- 5. Bill Gates**

ANS (3)-Linus Torvalds

Q92.The clock rate of a processor is measured in?

- 1. Milli seconds**
- 2. Micro hertz**
- 3. Megabytes or Gigabytes**
- 4. Nanoseconds**
- 5. Megahertz or Gigahertz**

ANS (5)-Megahertz or Gigahertz

Q93. The MDB Extensions refers to?

- 1. Hypertext related file**
- 2. System File**
- 3. Image file**
- 4. MS Access**
- 5. Animation/movie file**

ANS (4)-MS Access

Q94. 802.3 is the standard for?

- 1. Token bus**
- 2. Mesh network**
- 3. MAN**
- 4. Cable Modems**
- 5. Ethernet**

ANS (5)-Ethernet

Q95. A spooler is a?

- 1. Location in memory**
- 2. Print on paper**
- 3. Power on Self Test**
- 4. A program that controls spooling**
- 5. Message sent to the printer**

ANS (4)-A program that controls spooling

Q96. A DVD is an example of a (n)?

- 1. Hard disk**
- 2. Fibre Optical**
- 3. Output device**
- 4. Solid state storage device**
- 5. Optical Disc**

ANS (5)-Optical Disc

Q97. The intersection of row and column is known as?

- 1. Column**
- 2. Cell**
- 3. Address**
- 4. Attribute**
- 5. Tuples**

ANS (2)-Cell

Q98. What PPP protocol provides dynamic addressing, authentication, and multilink?

- 1. LCP**
- 2. HDLC**
- 3. X.25**
- 4. NCP**
- 5. None of these**

ANS (1)-LCP

Q99. Time taken for completing a task in computers is known as?

- 1. Down time**
- 2. Delay time**
- 3. Execution time**
- 4. Latency time**
- 5. Seek time**

ANS (3)-Execution time

Q100. The pathway connecting internal components of the microprocessor is called the?

- 1. System clock**
- 2. Instruction set**
- 3. IrDA port**
- 4. Data bus**
- 5. None of these**

ANS (4)-Data bus

Pdf Download from: www.Sarkaripost.in

TIME TO FINAL PREPARATION

LET'S START WITH MAHENDRAS



FACILITIES FOR STUDENTS

- Exclusive Student Portal (stportal.mahendras.org)
- Up to Selection Facility.* (For Selected Cards Only)
- Smart Lab
- Online Speed Test
- Written Speed Test (Detailed Result Analysis)
- Mahendras Class Assessment (MCA)
- Distribution of Class Worksheet (CWE)
- Study Material (English/Hindi)
- Student Bags (One at the time of Admission and another on qualifying PRE Exam or selection.)
- E-NEWSPAPER & MICA (Online & Offline)
- PSS/Online PSS/Online Videos
- Batch/Branch Transfer
- Batch Re-joining* (For Selected Cards Only)
- Smart Class
- Star Performer Award (Monthly)
- Interview and GD PI Facility
- Counselling After Qualifying Pre Examination
- Alumni Facility (Many more Advantages)



BANK



SSC



RAILWAY



STATE LEVEL EXAM